



PATRICIAN FULL-L LEFT

SOLD TO: _____
 TAG NAME: _____
 DATE: _____ P.O.: _____

LINER INFO:

WALL PATTERN _____
 FLOOR PATTERN _____
 MIL _____

BEAD TYPE:

STANDARD _____
 OTHER _____
 NO BEAD _____

SAFETY LEDGE:

LEDGE 1 (L1) _____
 BACK LEDGE (BL) _____
 LEDGE 2 (L2) _____

SLOPE TYPE:

INDICATE IRREGULAR SLOPES ON THE DIAGRAM WITH "X"

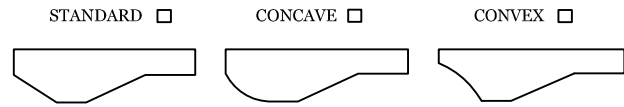

CORNER SIZE & TYPE:

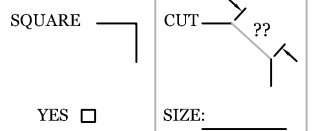

RADIUS

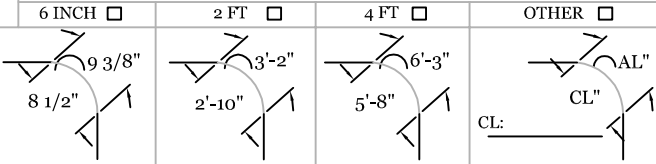

STAIR: NO YES

SIZE OF STAIR _____
 TYPE OF STAIR: STRAIGHT CURVED

FOR VINYL OVER STAIR FILL OUT & ATTACH STEP DETAIL SHEET.

POOL PROFILE:

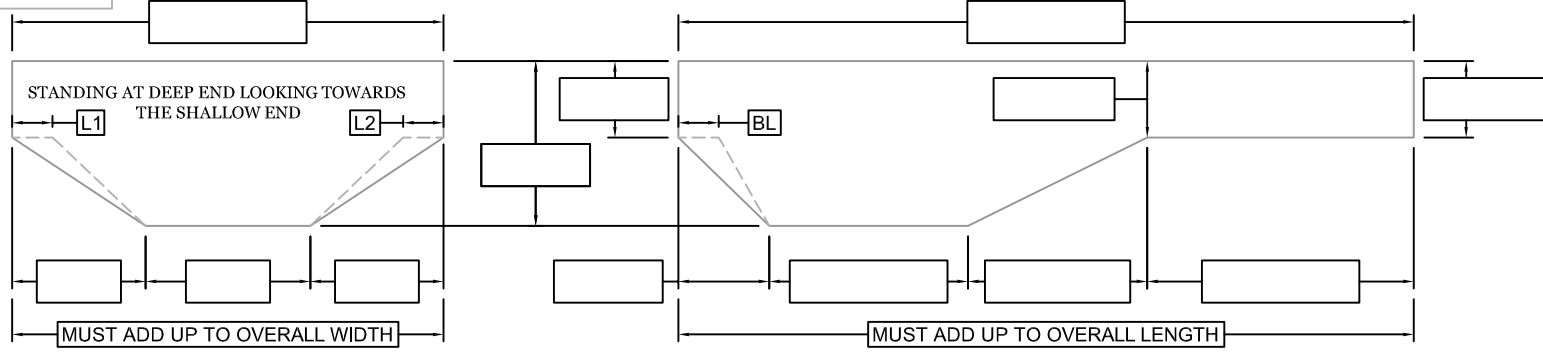

DIAGONALS:

1	
2	
3	
4	
5	
6	
7	
8	
9	
10	
11	
12	
13	
14	
15	
16	
17	

PANEL DIMENSIONS:

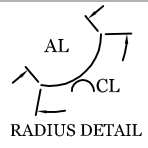
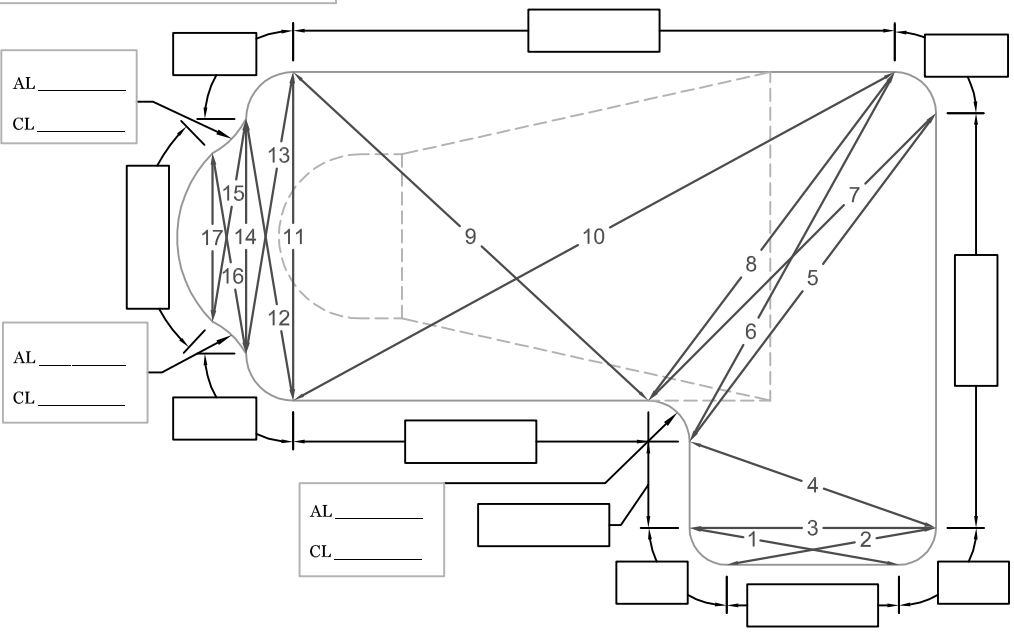

PATRICIAN END DETAILS:

PROVIDE ALL MEASUREMENTS AS SHOWN IF THERE IS A STRAIGHT BEFORE THE REVERSE TO ENSURE PATRICIAN END IS CONSTRUCTED ACCURATELY.

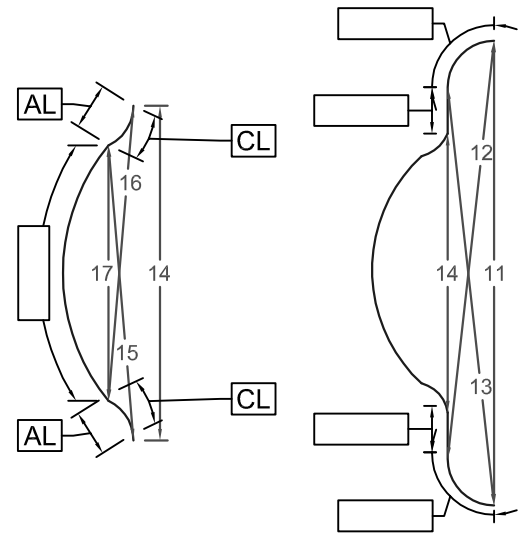

HOPPER STYLE:
 ROUND
 SQUARE

NOTES:



PATRICIAN FULL-L RIGHT

SOLD TO: _____
 TAG NAME: _____
 DATE: _____ P.O.: _____

LINER INFO:

WALL PATTERN _____
 FLOOR PATTERN _____
 MIL _____

BEAD TYPE:

STANDARD _____
 OTHER _____
 NO BEAD _____

SAFETY LEDGE:

LEDGE 1 (L1) _____
 BACK LEDGE (BL) _____
 LEDGE 2 (L2) _____

SLOPE TYPE:

INDICATE IRREGULAR SLOPES ON THE DIAGRAM WITH "X"

STANDARD CONCAVE CONVEX

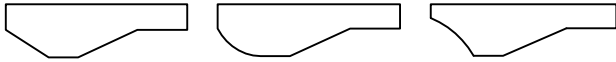

CORNER SIZE & TYPE:

SQUARE CUT ??
 YES SIZE: _____

RADIUS
 6 INCH 2 FT 4 FT OTHER

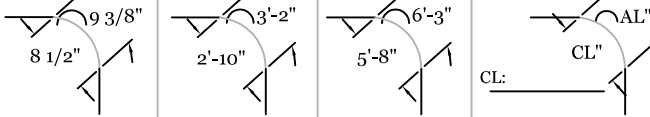

STAIR: NO YES

SIZE OF STAIR _____
 TYPE OF STAIR: STRAIGHT
 CURVED

FOR VINYL OVER STAIR FILL OUT & ATTACH STEP DETAIL SHEET.

POOL PROFILE:

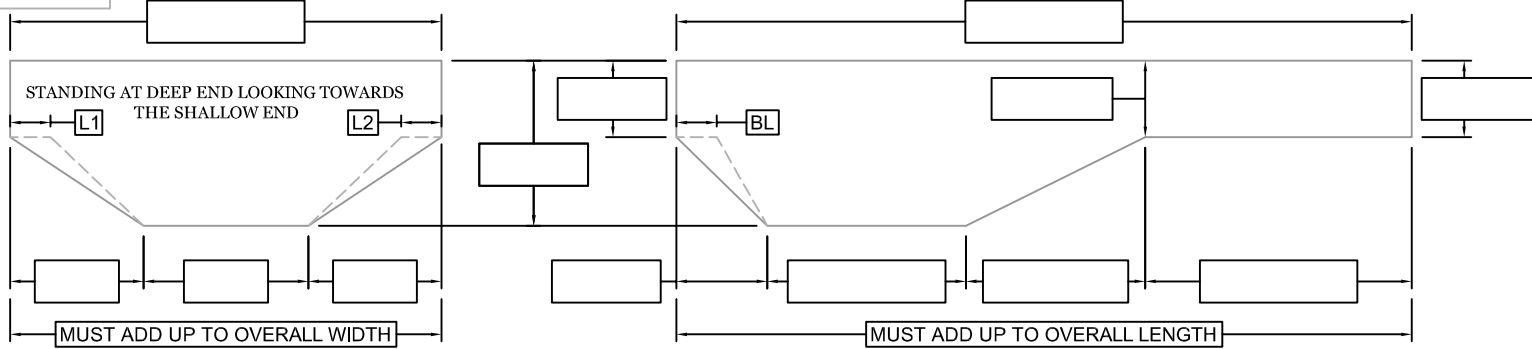

DIAGONALS:

1	
2	
3	
4	
5	
6	
7	
8	
9	
10	
11	
12	
13	
14	
15	
16	
17	

PANEL DIMENSIONS:

HOPPER STYLE:

ROUND
 SQUARE

AL _____
 CL _____

AL _____
 CL _____

AL _____
 CL _____

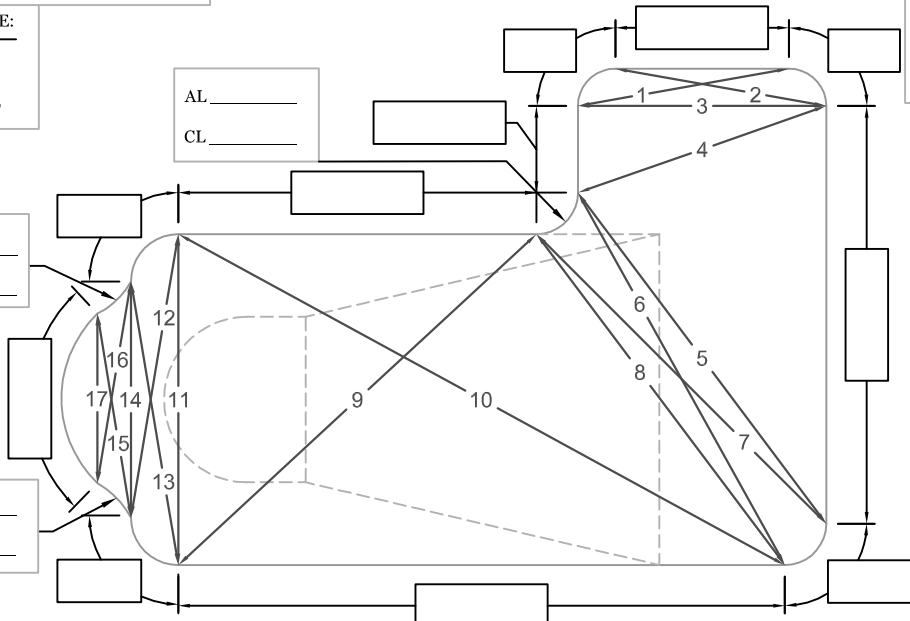

PATRICIAN END DETAILS:

PROVIDE ALL MEASUREMENTS AS SHOWN IF THERE IS A STRAIGHT BEFORE THE REVERSE TO ENSURE PATRICIAN END IS CONSTRUCTED ACCURATELY.

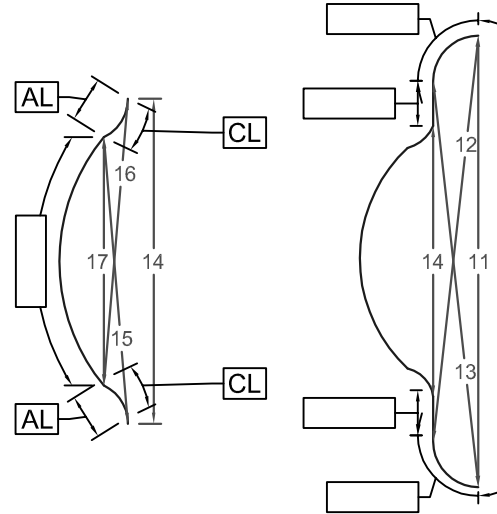
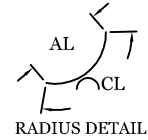

NOTES:



SOLD TO: _____
 TAG NAME: _____
 DATE: _____
 P.O.: _____

LINER INFO:
 WALL PATTERN _____
 FLOOR PATTERN _____
 MIL _____

BEAD TYPE:
 STANDARD _____
 OTHER _____
 NO BEAD _____

SLOPE TYPE:
 STANDARD
 CONCAVE
 CONVEX
 INDICATE IRREGULAR SLOPES ON THE DIAGRAM WITH "X"

SAFETY LEDGE:
 LEDGE 1 _____
 BACK LEDGE _____
 LEDGE 2 _____

POOL INFO:
 WALL HEIGHT _____ LENGTH _____
 DEPTH _____ WIDTH _____
 PERIMETER: _____

STAIR: NO YES STAIR POINTS:
 SIZE OF STAIR _____ POSITION A B
 TYPE OF STAIR: STRAIGHT START
 CURVED END
 FOR VINYL OVER STAIR FILL OUT AND ATTACH STEP DETAIL SHEET.

#	A	B	#	A	B
1			26		
2			27		
3			28		
4			29		
5			30		
6			31		
7			32		
8			33		
9			34		
10			35		
11			36		
12			37		
13			38		
14			39		
15			40		
16			41		
17			42		
18			43		
19			44		
20			45		
21			46		
22			47		
23			48		
24			49		
25			50		

PLEASE SELECT AND FILL THE A-B LOCATION THAT IS MOST APPLICABLE TO THE POOL YOU ARE MEASURING.

PATRICIAN FULL L LEFT

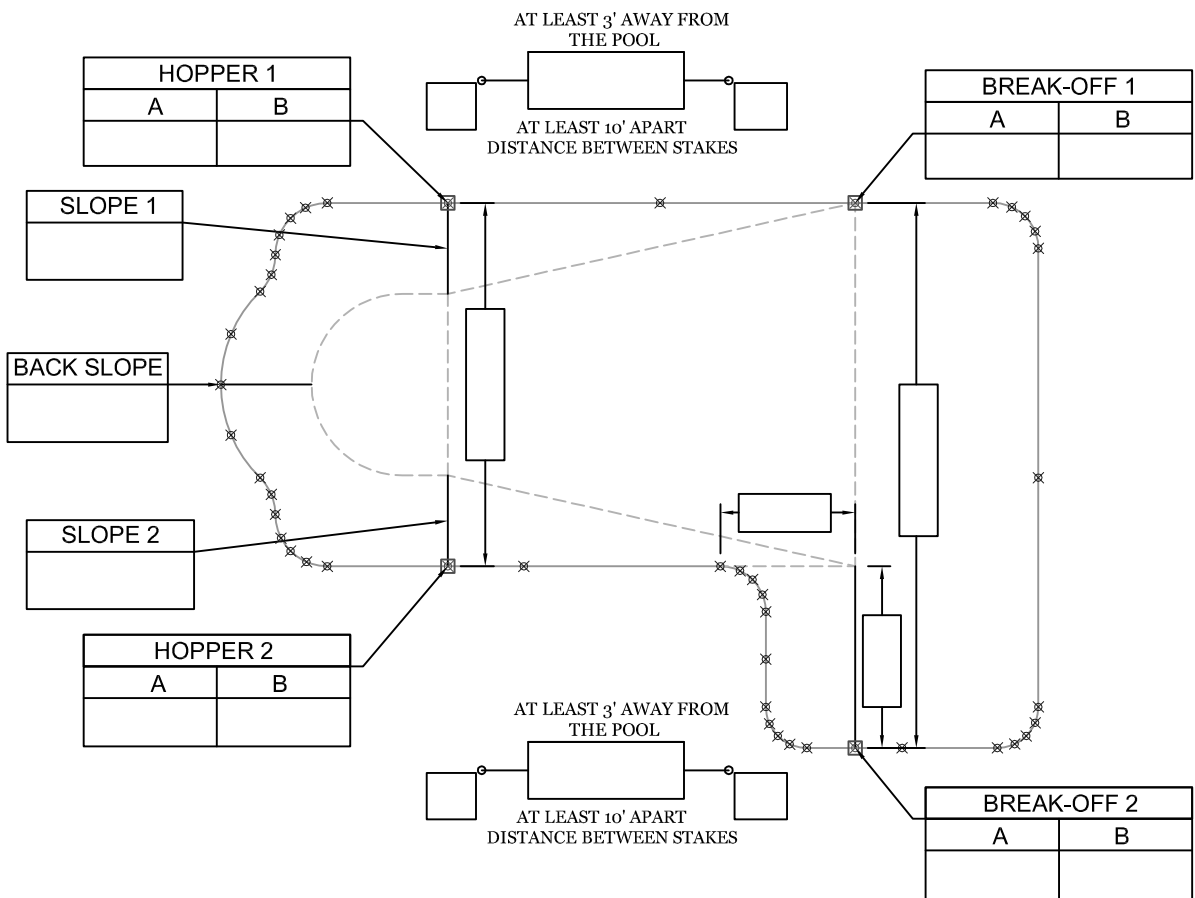



SOLD TO: _____
 TAG NAME: _____
 DATE: _____
 P.O: _____

LINER INFO:
 WALL PATTERN _____
 FLOOR PATTERN _____
 MIL _____

BEAD TYPE:
 STANDARD _____
 OTHER _____
 NO BEAD _____

SLOPE TYPE:
 STANDARD
 CONCAVE
 CONVEX
 INDICATE IRREGULAR SLOPES ON THE DIAGRAM WITH "X"

SAFETY LEDGE:
 LEDGE 1 _____
 BACK LEDGE _____
 LEDGE 2 _____

POOL INFO:
 WALL HEIGHT _____ LENGTH _____
 DEPTH _____ WIDTH _____
 PERIMETER: _____

STAIR: NO YES STAIR POINTS:
 SIZE OF STAIR _____ POSITION A B
 TYPE OF STAIR: STRAIGHT START
 CURVED END
 FOR VINYL OVER STAIR FILL OUT AND ATTACH STEP DETAIL SHEET.

#	A	B	#	A	B
1			26		
2			27		
3			28		
4			29		
5			30		
6			31		
7			32		
8			33		
9			34		
10			35		
11			36		
12			37		
13			38		
14			39		
15			40		
16			41		
17			42		
18			43		
19			44		
20			45		
21			46		
22			47		
23			48		
24			49		
25			50		

PATRICIAN FULL L RIGHT

PLEASE SELECT AND FILL THE A-B LOCATION THAT IS MOST APPLICABLE TO THE POOL YOU ARE MEASURING.

