



OVAL LAZY-L LEFT

SOLD TO: _____
 TAG NAME: _____
 DATE: _____ P.O.: _____

LINER INFO:

WALL PATTERN _____
 FLOOR PATTERN _____
 MIL _____

BEAD TYPE:

STANDARD _____
 OTHER _____
 NO BEAD _____

SAFETY LEDGE:

LEDGE 1 (L1) _____
 BACK LEDGE (BL) _____
 LEDGE 2 (L2) _____

SLOPE TYPE:

INDICATE IRREGULAR SLOPES ON THE DIAGRAM WITH "X"

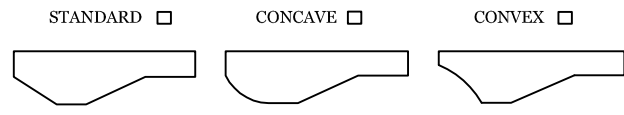

CORNER SIZE & TYPE:

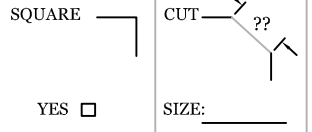

RADIUS

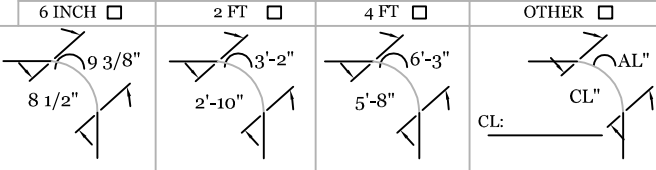

STAIR: NO YES

SIZE OF STAIR _____
 TYPE OF STAIR: STRAIGHT CURVED

FOR VINYL OVER STAIR FILL OUT & ATTACH STEP DETAIL SHEET.

POOL PROFILE:

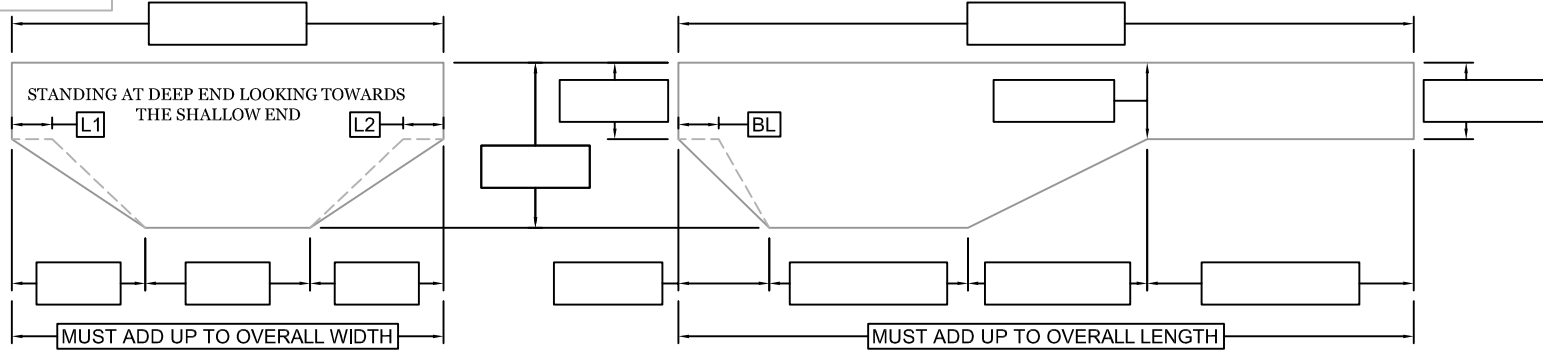

DIAGONALS:

1	
2	
3	
4	
5	
6	
7	
8	
9	
10	
11	
12	

PANEL DIMENSIONS:

HOPPER STYLE:
 ROUND
 SQUARE

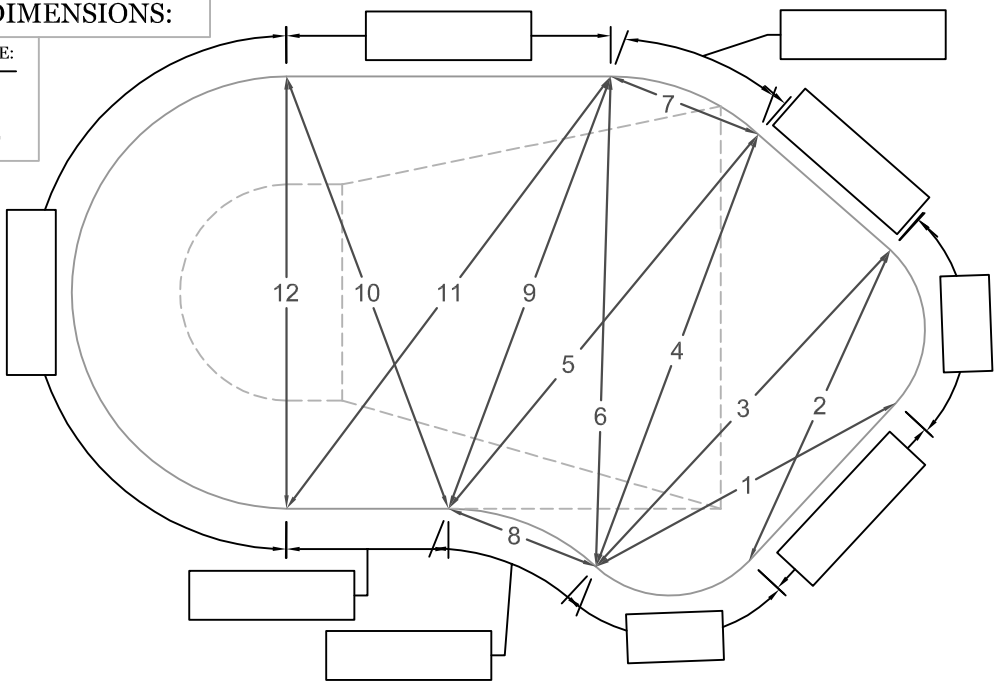

BREAK-OFF & STEP LOCATION:

PROVIDE STEP LOCATION MEASUREMENT FROM THE CLOSEST PANEL JOINT. SHOW STEP ON DIAGRAM AND MARK PANEL JOINT WHERE MEASUREMENT WAS TAKEN FROM.

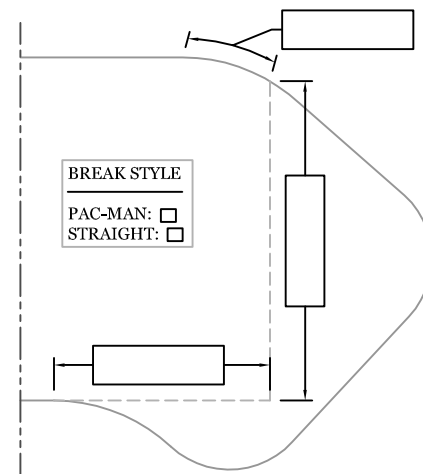

STEP DISTANCE FROM PANEL: _____

NOTES:



OVAL LAZY-L RIGHT

SOLD TO: _____
 TAG NAME: _____
 DATE: _____ P.O.: _____

LINER INFO:
 WALL PATTERN _____
 FLOOR PATTERN _____
 MIL _____

BEAD TYPE:
 STANDARD _____
 OTHER _____
 NO BEAD _____

SAFETY LEDGE:
 LEDGE 1 (L1) _____
 BACK LEDGE (BL) _____
 LEDGE 2 (L2) _____

SLOPE TYPE: INDICATE IRREGULAR SLOPES ON THE DIAGRAM WITH "X"

STANDARD CONCAVE CONVEX

CORNER SIZE & TYPE:

SQUARE CUT ?? YES SIZE: _____

RADIUS

6 INCH 2 FT 4 FT OTHER

STAIR: NO YES

SIZE OF STAIR _____

TYPE OF STAIR: STRAIGHT CURVED

FOR VINYL OVER STAIR FILL OUT & ATTACH STEP DETAIL SHEET.

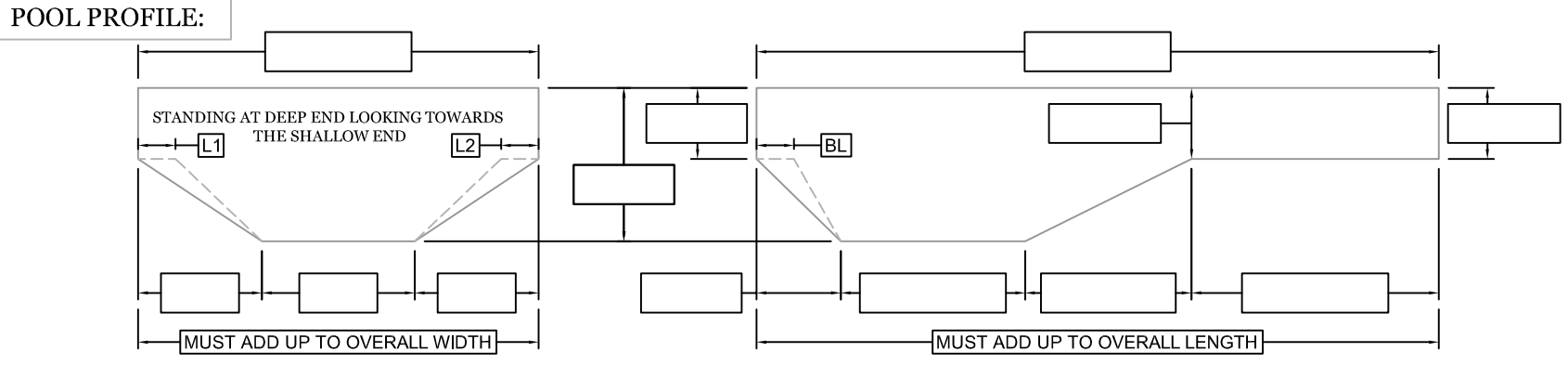

DIAGONALS:

1	
2	
3	
4	
5	
6	
7	
8	
9	
10	
11	
12	

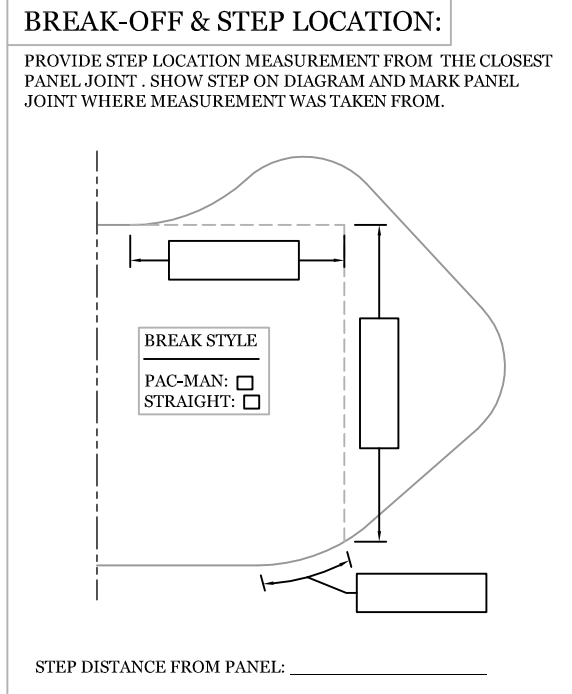
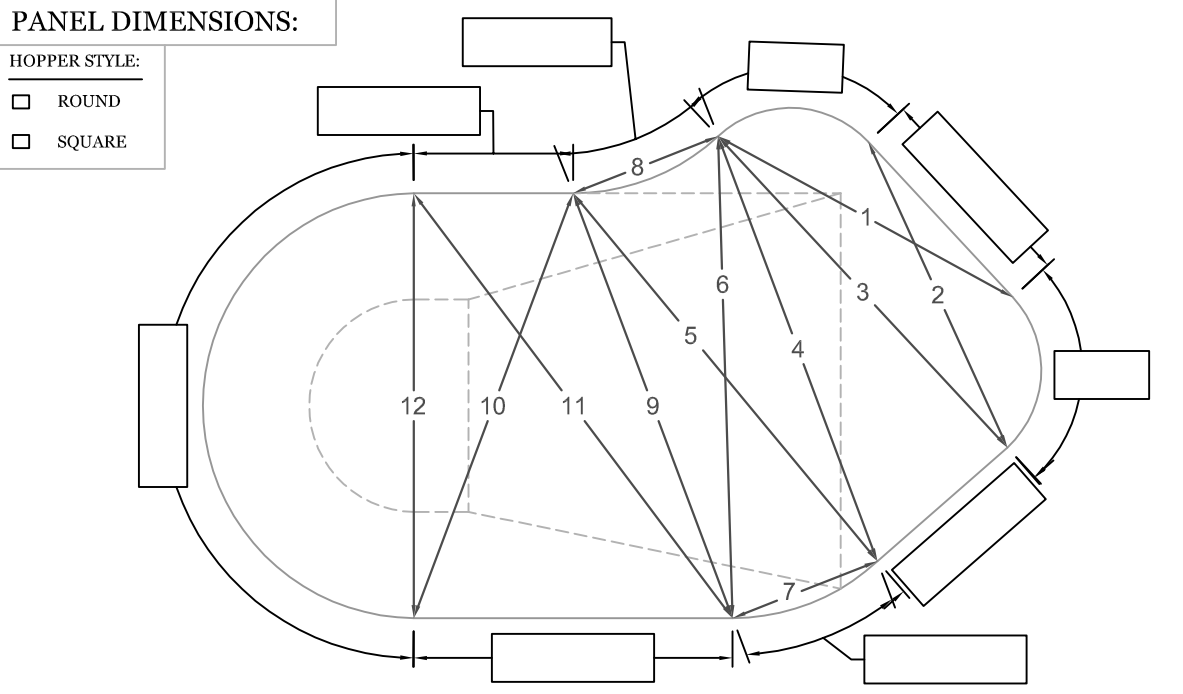

NOTES:



SOLD TO: _____
 TAG NAME: _____
 DATE: _____
 P.O: _____

LINER INFO:
 WALL PATTERN _____
 FLOOR PATTERN _____
 MIL _____

BEAD TYPE:
 STANDARD _____
 OTHER _____
 NO BEAD _____

SLOPE TYPE:
 STANDARD
 CONCAVE
 CONVEX
 INDICATE IRREGULAR SLOPES ON THE DIAGRAM WITH " X "

SAFETY LEDGE:
 LEDGE 1 _____
 BACK LEDGE _____
 LEDGE 2 _____

POOL INFO:
 WALL HEIGHT _____ LENGTH _____
 DEPTH _____ WIDTH _____
 PERIMETER: _____

STAIR: NO YES STAIR POINTS:
 SIZE OF STAIR _____ POSITION A B
 TYPE OF STAIR: STRAIGHT START
 CURVED END
 FOR VINYL OVER STAIR FILL OUT AND ATTACH STEP DETAIL SHEET.

#	A	B	#	A	B
1			26		
2			27		
3			28		
4			29		
5			30		
6			31		
7			32		
8			33		
9			34		
10			35		
11			36		
12			37		
13			38		
14			39		
15			40		
16			41		
17			42		
18			43		
19			44		
20			45		
21			46		
22			47		
23			48		
24			49		
25			50		

OVAL LAZY L LEFT

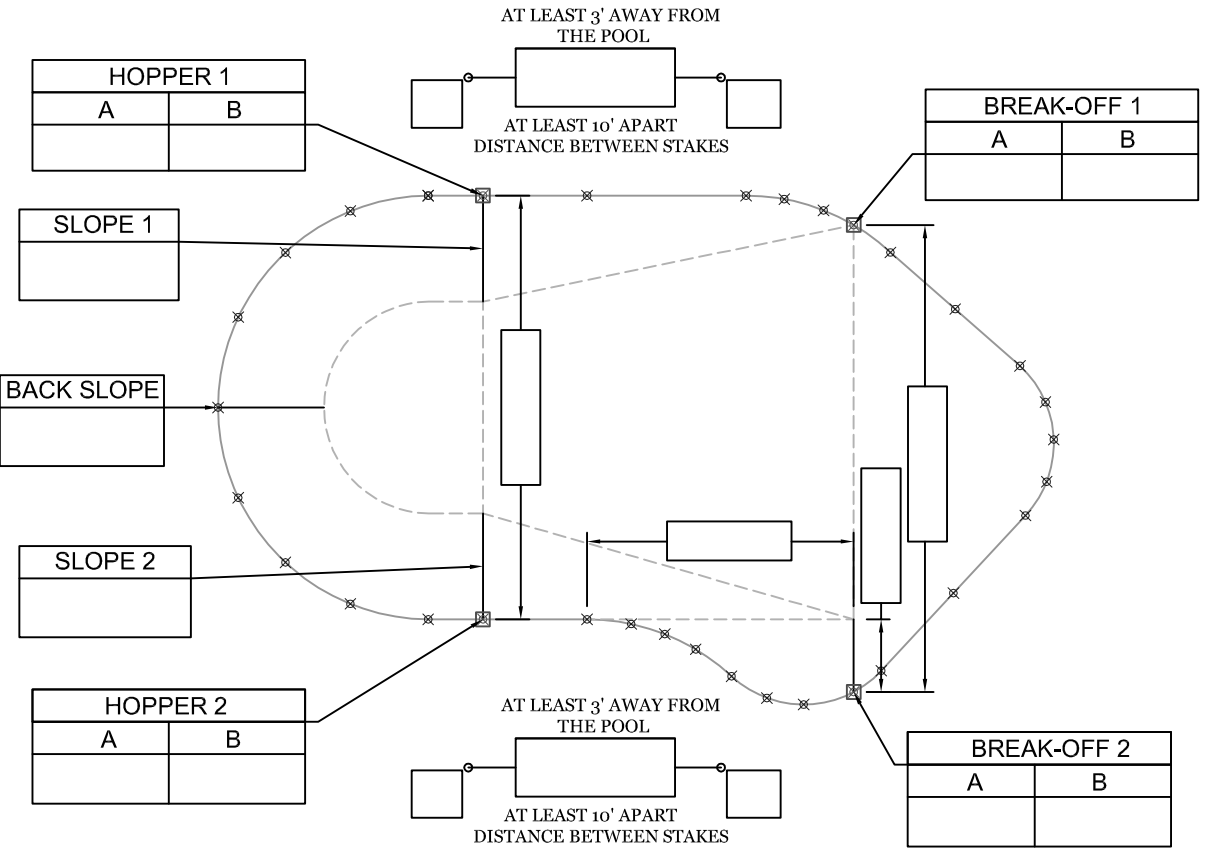





SOLD TO: _____
 TAG NAME: _____
 DATE: _____
 P.O.: _____

LINER INFO:
 WALL PATTERN _____
 FLOOR PATTERN _____
 MIL _____

BEAD TYPE:
 STANDARD _____
 OTHER _____
 NO BEAD _____

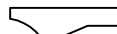
SLOPE TYPE:
 STANDARD 
 CONCAVE 
 CONVEX 
 INDICATE IRREGULAR SLOPES ON THE DIAGRAM WITH "X"

SAFETY LEDGE:
 LEDGE 1 _____
 BACK LEDGE _____
 LEDGE 2 _____

POOL INFO:
 WALL HEIGHT _____ LENGTH _____
 DEPTH _____ WIDTH _____
 PERIMETER: _____

STAIR: NO YES STAIR POINTS:
 SIZE OF STAIR _____ POSITION A B
 TYPE OF STAIR: STRAIGHT START
 CURVED END
 FOR VINYL OVER STAIR FILL OUT AND ATTACH STEP DETAIL SHEET.

#	A	B	#	A	B
1			26		
2			27		
3			28		
4			29		
5			30		
6			31		
7			32		
8			33		
9			34		
10			35		
11			36		
12			37		
13			38		
14			39		
15			40		
16			41		
17			42		
18			43		
19			44		
20			45		
21			46		
22			47		
23			48		
24			49		
25			50		

OVAL LAZY L RIGHT

PLEASE SELECT AND FILL THE A-B LOCATION THAT IS MOST APPLICABLE TO THE POOL YOU ARE MEASURING.

